

### Features

- Ultrafast recovery
- Low power losses
- High surge capability
- Low leakage current
- High junction temperature
- ECOPACK<sup>®</sup>2 compliant component for DPAK on demand

### Description

The STTH1003S is an ultrafast recovery power rectifier dedicated to energy recovery in PDP applications.

It is especially designed for clamping function in energy recovery block. The compromise between forward voltage drop and recovery time offers optimized performances.

**Table 1. Device summary**

Symbol	Value
$I_{F(AV)}$	10 A
$V_{RRM}$	300 V
$t_{rr}(typ)$	13 ns
$T_j(max)$	175 °C
$V_F(typ)$	0.9 V

# 1 Characteristics

**Table 2. Absolute ratings (limiting values, at 25 °C, unless otherwise specified)**

Symbol	Parameter		Value	Unit
$V_{RRM}$	Repetitive peak reverse voltage		300	V
$I_{F(RMS)}$	Forward rms current		20	A
$I_{F(AV)}$	Average forward current $\delta = 0.5$ , square wave	$T_c = 150\text{ °C}$	10	A
$I_{FSM}$	Surge non repetitive forward current	$t_p = 10\text{ ms}$ sinusoidal	100	A
$I_{RSM}$	Non repetitive peak reverse current	$t_p = 20\text{ }\mu\text{s}$ square	4	A
$T_{stg}$	Storage temperature range		-65 to +175	°C
$T_j$	Maximum operating junction temperature		175	°C

**Table 3. Thermal resistance**

Symbol	Parameter	Package	Max. value	Unit
$R_{th(j-c)}$	Junction to case	DPAK	4	°C/W

**Table 4. Static electrical characteristics**

Symbol	Parameter	Test conditions		Min.	Typ.	Max.	Unit
$I_R^{(1)}$	Reverse leakage current	$T_j = 25\text{ °C}$	$V_R = V_{RRM}$	-	-	10	$\mu\text{A}$
		$T_j = 125\text{ °C}$		-	10	100	
$V_F^{(2)}$	Forward voltage drop	$T_j = 25\text{ °C}$	$I_F = 10\text{ A}$	-	-	1.30	V
		$T_j = 125\text{ °C}$		-	0.90	1.10	

1. Pulse test:  $t_p = 5\text{ ms}$ ,  $\delta < 2\%$

2. Pulse test:  $t_p = 380\text{ }\mu\text{s}$ ,  $\delta < 2\%$

To evaluate the conduction losses, use the following equation:

$$P = 0.86 \times I_{F(AV)} + 0.024 \times I_{F(RMS)}^2$$

Table 5. Dynamic electrical characteristics

Symbol	Parameter	Test conditions		Min.	Typ.	Max.	Unit
$t_{rr}$	Reverse recovery time	$T_j = 25\text{ °C}$	$I_F = 0.5\text{ A}$ $I_{rr} = 0.25\text{ A}$ $I_R = 1\text{ A}$	-	13	17	ns
			$I_F = 1\text{ A}$ $V_R = 30\text{ V}$ $di_F/dt = -50\text{ A}/\mu\text{s}$	-	28	35	
$t_{fr}$	Forward recovery time	$T_j = 25\text{ °C}$	$I_F = 10\text{ A}$ $V_{FR} = 1.1 \times V_{Fmax}$ $di_F/dt = 100\text{ A}/\mu\text{s}$	-	-	200	ns
$V_{FP}$	Peak forward voltage		$I_F = 10\text{ A}$ $di_F/dt = 100\text{ A}/\mu\text{s}$	-	2.5	3.5	V
$I_{RM}$	Reverse recovery current	$T_j = 125\text{ °C}$	$I_F = 10\text{ A}$ $V_R = 200\text{ V}$ $di_F/dt = 200\text{ A}/\mu\text{s}$	-	5.7	7.5	A
$S_{factor}$	Softness factor		$I_F = 10\text{ A}$ $V_R = 200\text{ V}$ $di_F/dt = 200\text{ A}/\mu\text{s}$	-	0.3	-	-

**Figure 1. Forward voltage drop versus forward current (maximum values)**

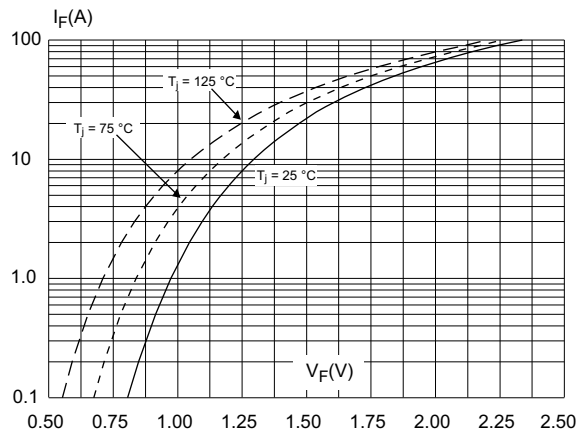

**Figure 2. Peak reverse recovery current versus  $dI_F/dt$  (typical values)**

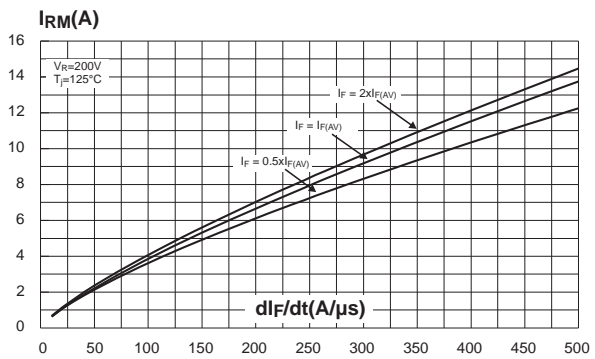

**Figure 3. Reverse recovery time versus  $dI_F/dt$  (typical values)**

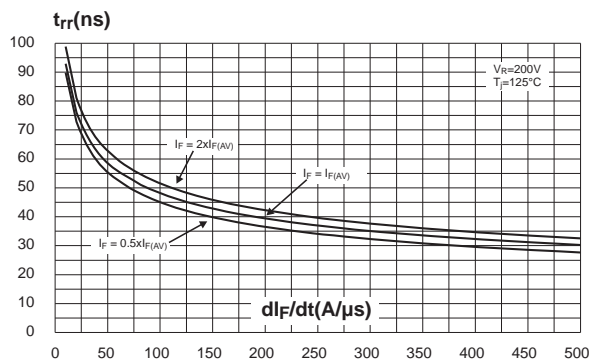

**Figure 4. Softness factor versus  $dI_F/dt$  (typical values)**

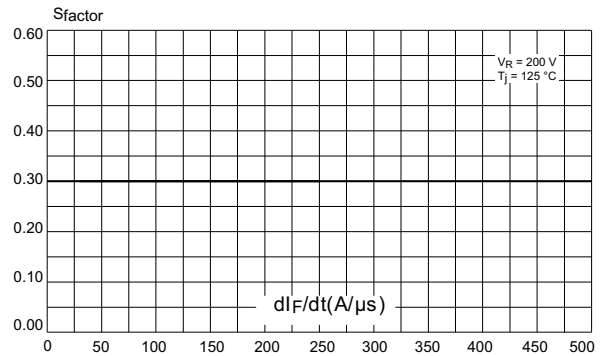

**Figure 5. Relative variations of dynamic parameters versus junction temperature (reference:  $T_j = 125^\circ\text{C}$ )**

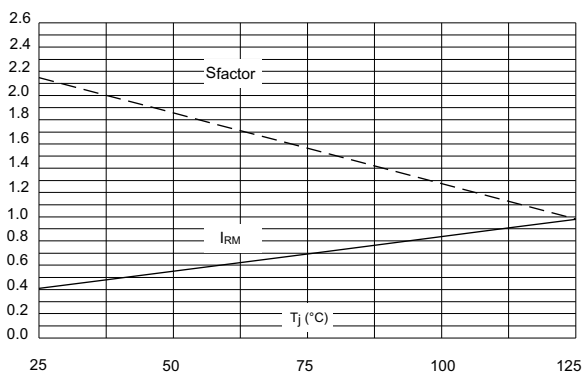

**Figure 6. Transient peak forward voltage versus  $dI_F/dt$  (typical values)**

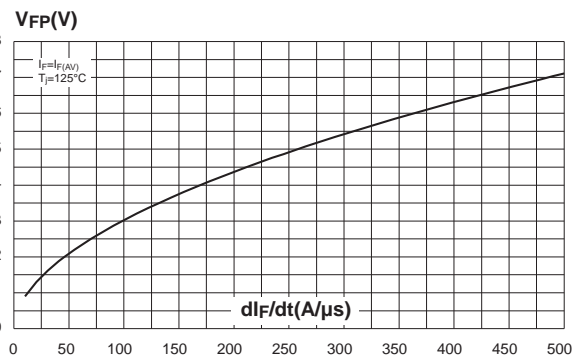
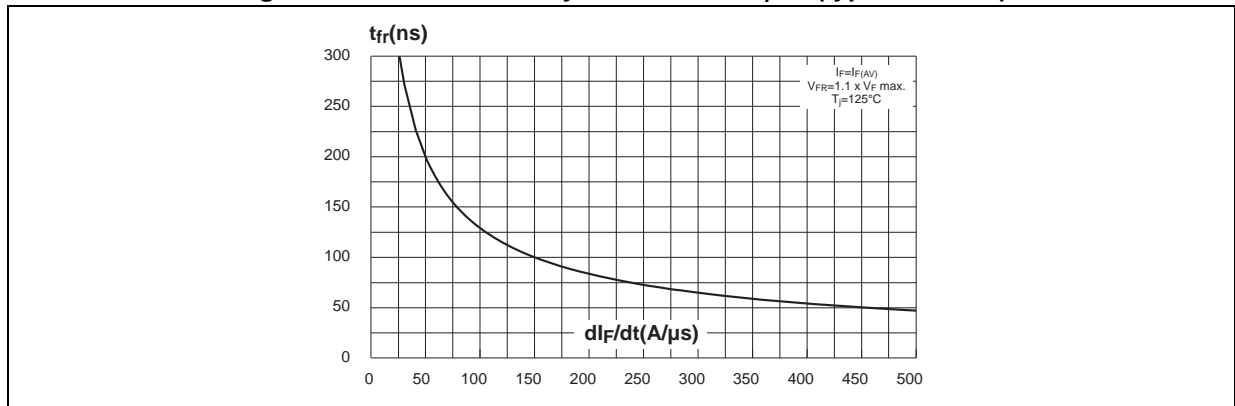

Figure 7. Forward recovery time versus  $di_F/dt$  (typical values)

## 2 Package Information

- Epoxy meets UL94, V0

In order to meet environmental requirements, ST offers these devices in different grades of ECOPACK® packages, depending on their level of environmental compliance. ECOPACK® specifications, grade definitions and product status are available at: [www.st.com](http://www.st.com). ECOPACK® is an ST trademark.

### 2.1 DPAK package information

Figure 8. DPAK package outline

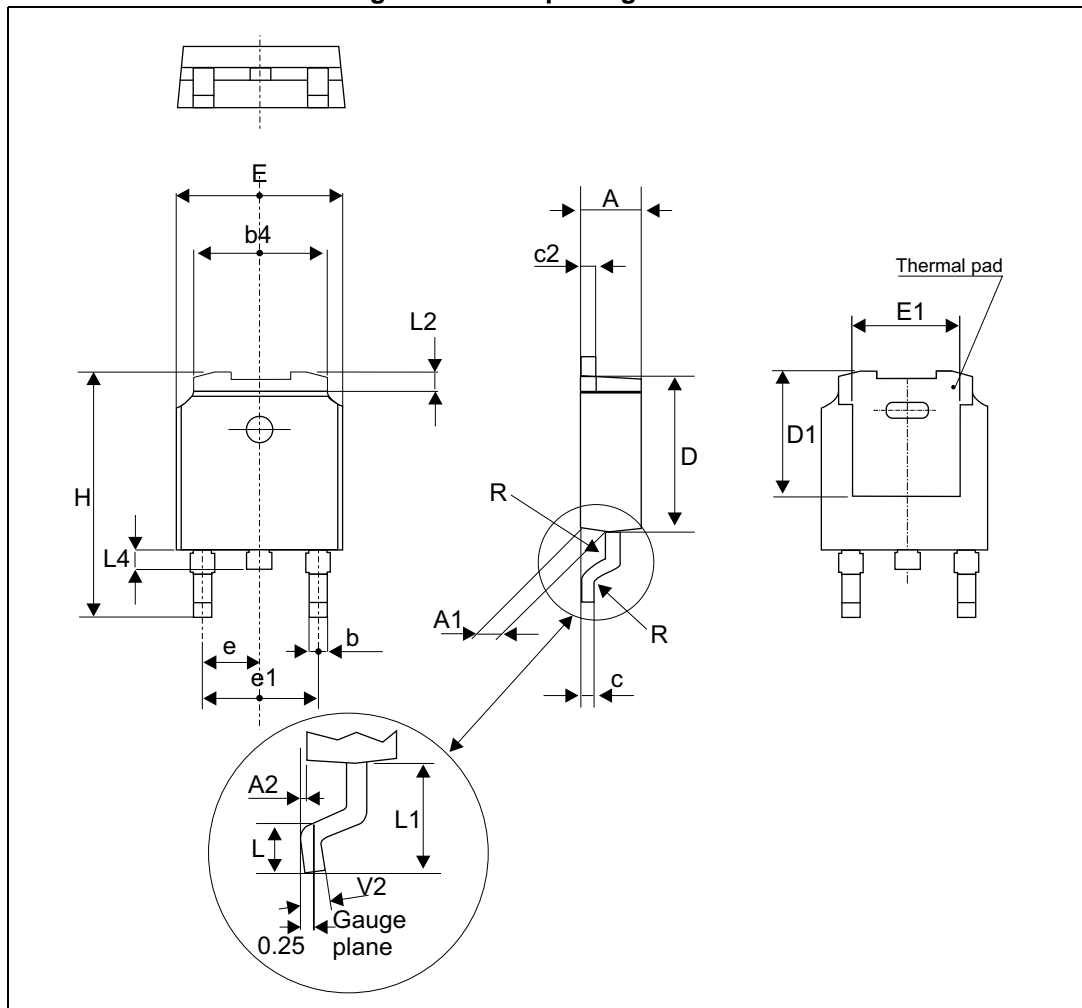

*Note:* This package drawing may slightly differ from the physical package. However, all the specified dimensions are guaranteed.

Table 6. DPAK package mechanical data

Ref.	Dimensions					
	Millimeters			Inches		
	Min.	Typ.	Max.	Min.	Typ.	Max.
A	2.18		2.40	0.085		0.094
A1	0.90		1.10	0.035		0.043
A2	0.03		0.23	0.001		0.009
b	0.64		0.90	0.025		0.035
b4	4.95		5.46	0.194		0.214
c	0.46		0.61	0.018		0.024
c2	0.46		0.60	0.018		0.023
D	5.97		6.22	0.235		0.244
D1	4.95		5.60	0.194		0.220
E	6.35		6.73	0.250		0.264
E1	4.32		5.50	0.170		0.216
e		2.28			0.090	
e1	4.40		4.70	0.173		0.185
H	9.35		10.40	0.368		0.409
L	1.00		1.78	0.039		0.070
L2			1.27			0.050
L4	0.60		1.02	0.023		0.040
V2	-8°		+8°	-8°		8°

Figure 9. DPAK footprint dimensions (in mm)

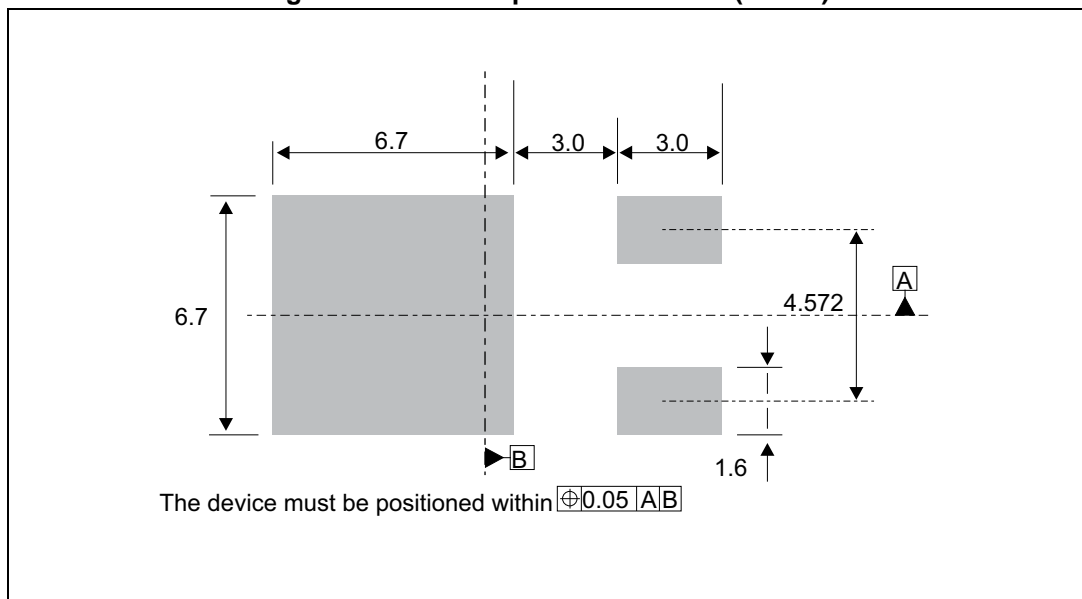

### 3 Ordering Information

**Table 7. Ordering information**

Order code	Marking	Package	Weight	Base qty.	Delivery mode
STTH1003SB-TR	STTH1 003S	DPAK	0.32 g	2500	Tape and reel

### 4 Revision history

**Table 8. Document revision history**

Date	Revision	Description of changes
24-Aug-2005	1	First issue.
18-May-2009	2	Reformatted to current standards. Modified configuration diagram on front page.
01-Apr-2014	3	Updated dimensions F1 and F2 in TO-220FPAB package dimensions.
01-Aug-2014	4	Updated DPAK package information and removed D <sup>2</sup> PAK and TO-220FPAB package and characteristics.
17-Sep-2014	5	Updated <i>Figure 8</i> and <i>Figure 9</i> .
14-Nov-2016	6	Updated DPAK package information and reformatted to current standard.



**IMPORTANT NOTICE – PLEASE READ CAREFULLY**

STMicroelectronics NV and its subsidiaries ("ST") reserve the right to make changes, corrections, enhancements, modifications, and improvements to ST products and/or to this document at any time without notice. Purchasers should obtain the latest relevant information on ST products before placing orders. ST products are sold pursuant to ST's terms and conditions of sale in place at the time of order acknowledgement.

Purchasers are solely responsible for the choice, selection, and use of ST products and ST assumes no liability for application assistance or the design of Purchasers' products.

No license, express or implied, to any intellectual property right is granted by ST herein.

Resale of ST products with provisions different from the information set forth herein shall void any warranty granted by ST for such product.

ST and the ST logo are trademarks of ST. All other product or service names are the property of their respective owners.

Information in this document supersedes and replaces information previously supplied in any prior versions of this document.

© 2016 STMicroelectronics – All rights reserved

